

Model RBA4040-346



Materials & Features

Stainless steel 40° WC right hand grab rail and 450mm straight rail meet the requirements of AS1428.1. The snap flange cover conceals the fixings.

Technical Detail

Rail: 32mm [Dia], 304 Satin Stainless Steel
 Fixings: By others

Available Model

RBA4040-346 40° Toilet Grab Rail Set, Right Hand

Related Products

RBA4040-345 40° Toilet Grab Rail Set, Left Hand

RBA4150-101 Accessible Compliant Backrest

Installation

Warning: Grab rails are no stronger than the anchors or walls to which they are attached and must be firmly secured in order to support the loads for which they are intended. Refer to local codes and Installation Instructions for location of fixing points, method of attachment, etc.

Important: Installation instructions and current rough-in details should be furnished with each fixture. Do not rough in without certified dimensions. Dimensions are subject to manufacturer's tolerance of +/-10mm.

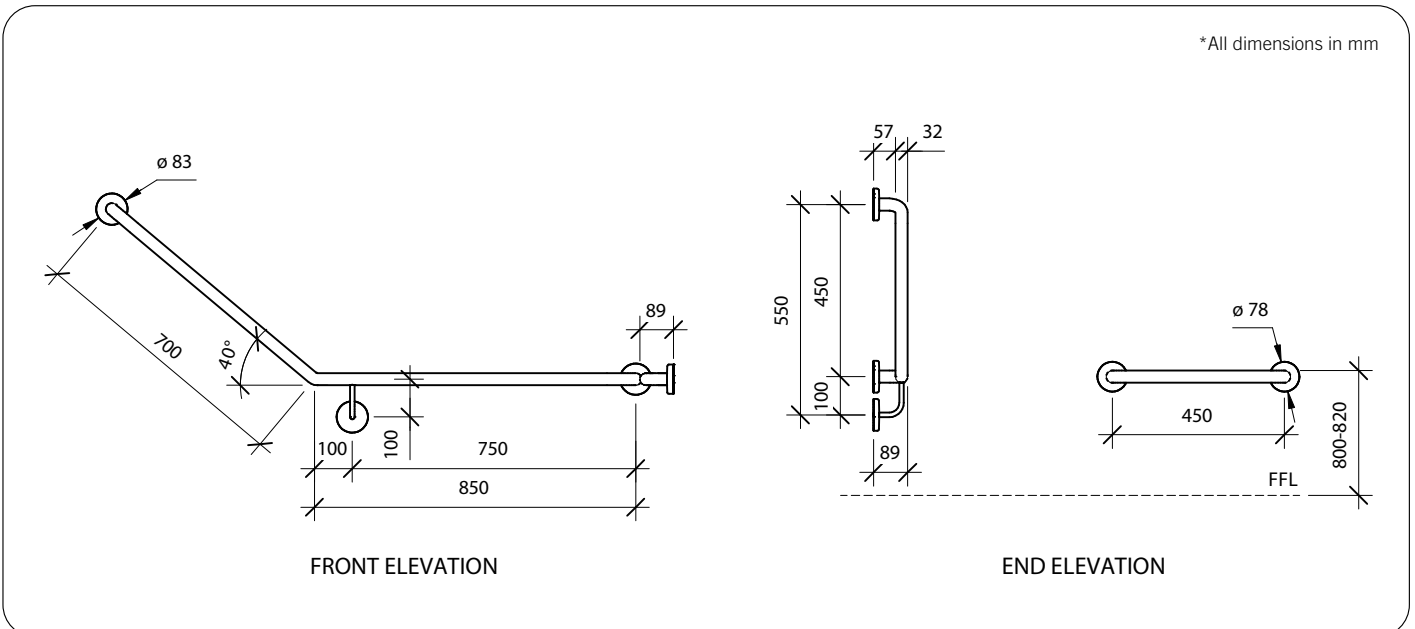

As improvements in the design and performance of RBA products are continuous, specifications may be subject to change without notice. The illustrations and descriptions herein are applicable to production as of the date of this Technical Data Sheet. Revised 11/22 © 2022 by RBA Group TD/Model RBA4040-346/1122