



Technical Data

SOLID PHENOLIC FOLDING SHOWER/DRESSING AREA SEAT

B-5193



For AS1428.1 compliance RBA recommends model B819687

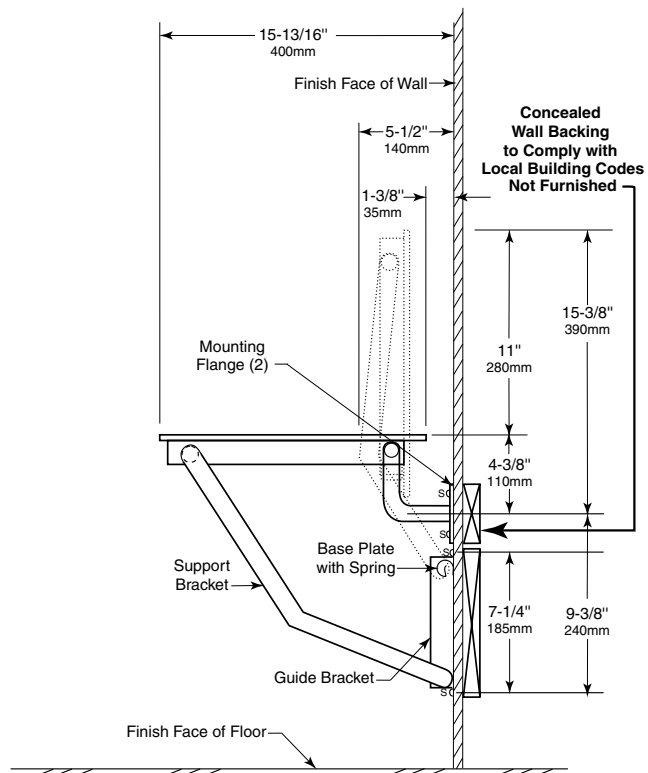
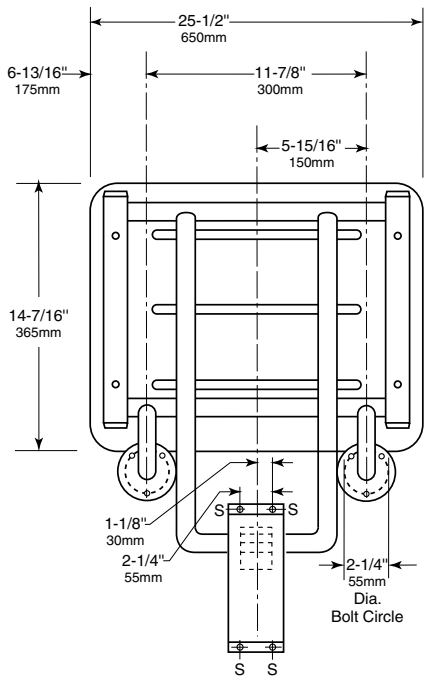

MATERIALS:

Seat — One-piece, 5/16" (8mm) thick, solidly fused plastic laminate with matte-finish melamine surfaces, ivory-colored face sheets, and black phenolic-resin core that are integrally bonded — cannot delaminate. Integral slots for water drainage. Secured to frame with stainless steel carriage bolts and acorn nuts.

Frame — 18-8, Type-304, stainless steel with satin finish. 16-gauge (1.6mm), 1-1/4" (30mm) square tubing and 18-gauge (1.2mm), 1" (25mm) diameter seamless tubing.

Mounting Flanges (2) — 18-8, Type-304, 3/16" (5mm) thick stainless steel with satin finish. 3" (75mm) diameter with three mounting screw holes.

Baseplate — 18-8, Type-304, heavy-gauge stainless steel.

Spring — 17-7, Type-301, 24-gauge (0.6mm) stainless steel. Spot-welded to baseplate.

Guide Bracket — 18-8, Type-304, 16-gauge (1.6mm) stainless steel with satin finish.

continued . . .

OPERATION:

Shower seat can be folded up against the wall when not in use. The spring at the top of baseplate holds seat into upright position until released by pulling the top of seat away from wall. Bobrick Folding Shower Seats are not spring-loaded. The seats do not return automatically to the upright position after use. Support system with guide bracket allows varying mounting heights and leaves floor clear for easier cleaning. Nonporous solid phenolic seat has slots to permit water to drain, does not splinter or require oiling, and will not support growth of bacteria. Slotless round-head carriage bolts and acorn nuts provide additional safety to user. Bobrick shower seats, when properly installed, have sufficient strength to support 500 lbs (227 kg).

INSTALLATION:

Secure unit to wall at points indicated by an S, with the two mounting flanges located at top and the baseplate and guide bracket below. The bottom of support bracket must be positioned between the baseplate and guide bracket before they are secured to wall or partition. Mounting height of shower seat must comply with local building codes.

For stud walls, provide concealed backing to comply with local building codes and secure with #14 x 2-1/2" (6.3 x 65mm) stainless steel sheet-metal screws furnished by manufacturer.

For prefabricated shower stalls, provide adequate backing by the shower stall manufacturer. Secure with #14 x 2-1/2" (6.3 x 65mm) stainless steel mounting screws furnished by manufacturer.

For masonry walls, provide fiber plugs or expansion shields for use with furnished sheet-metal screws, or provide 1/4" (6mm) toggle bolts or expansion bolts.

INSTALL SAFETY PLATE TO WALL:

Safety Plate is to be mounted on wall near Shower Seat in order to properly advise users of the Seat's weight restrictions. Correct installation of the Safety Plate will ensure that the Shower Seat meets A.N.S.I. Standards.

Permanently affix Safety Plate to wall on either side of the Shower Seat at a minimum height of 30" (760mm). If mounted above Seat, the Plate must be high enough so that it is not covered when Seat is on the up position. Mounting screws (4) are recommended, but double-sided tape on rear of Plate may be used for very smooth, non-porous surfaces.

SAFETY WARNING: Shower seats are no stronger than the anchors and walls to which they are attached and must be firmly secured in order to support the loads for which they are intended. Consult and comply with local building codes. To avoid potential injury, the building owner or maintenance personnel should remove the shower seat from service if the shower seat is not adequately secured to the wall. Unit shall support static loads of up to 500 lbs (227 kg) when properly installed and used. To avoid potential seat malfunction, DO NOT use seat if weight exceeds 500 lbs (227 kg).

SPECIFICATION:

Folding shower seat shall have a frame constructed of Type-304, satin-finish stainless steel that consists of 16-gauge (1.6mm), 1-1/4" (30mm) square tubing and 18-gauge (1.2mm), 1" (25mm) diameter seamless tubing. Seat shall be one-piece, 5/16" (8mm) thick, solidly fused plastic laminate with matte-finish melamine surfaces, ivory-colored face sheets, and black phenolic-resin core; secured to frame with stainless steel carriage bolts and acorn nuts. Shower seat shall be equipped with two 3" (75mm) diameter mounting flanges constructed of Type-304, 3/16" (5mm) thick, satin-finish stainless steel; a guide bracket constructed of Type-304, 16-gauge (1.6mm), satin-finish stainless steel; and a spring constructed of Type-301, 24-gauge (0.6mm) stainless steel that is spot-welded to a baseplate of Type-304, heavy-gauge stainless steel. Seat shall be able to lock in upright position when not in use.

Folding Shower Seat shall be Model B-5193 of Bobrick Washroom Equipment, Inc., Clifton Park, New York; Jackson, Tennessee; Los Angeles, California; Bobrick Washroom Equipment Company, Scarborough, Ontario; Bobrick Washroom Equipment Pty. Ltd., Australia; and Bobrick Washroom Equipment Limited, United Kingdom.