

Model RBA1631-322

Materials & Features

Manufactured from heavy duty brass with all exposed surfaces in a matte black finish. oken is a suite of attractive commercial grade accessories with radiused corners and edges to increase comfort and minimise catch.



Technical Detail

Material:	Heavy Duty Brass
Finish:	Matte Black
Bracket:	12mm Heavy Duty Brass Lug
Fixings:	Included

Available Model

RBA1631-322 oken Double Toilet Roll Holder, Matte Black

Related Products

- RBA1631-300** oken Robe Hook, Matte Black
- RBA1631-302** oken Toilet Roll Holder #1, Matte Black
- RBA1631-304** oken Towel Rail #1, Matte Black

Important: Installation instructions and current rough-in details should be furnished with each fixture. Do not rough in without certified dimensions. Dimensions are subject to manufacturer's tolerance of +/-10mm.

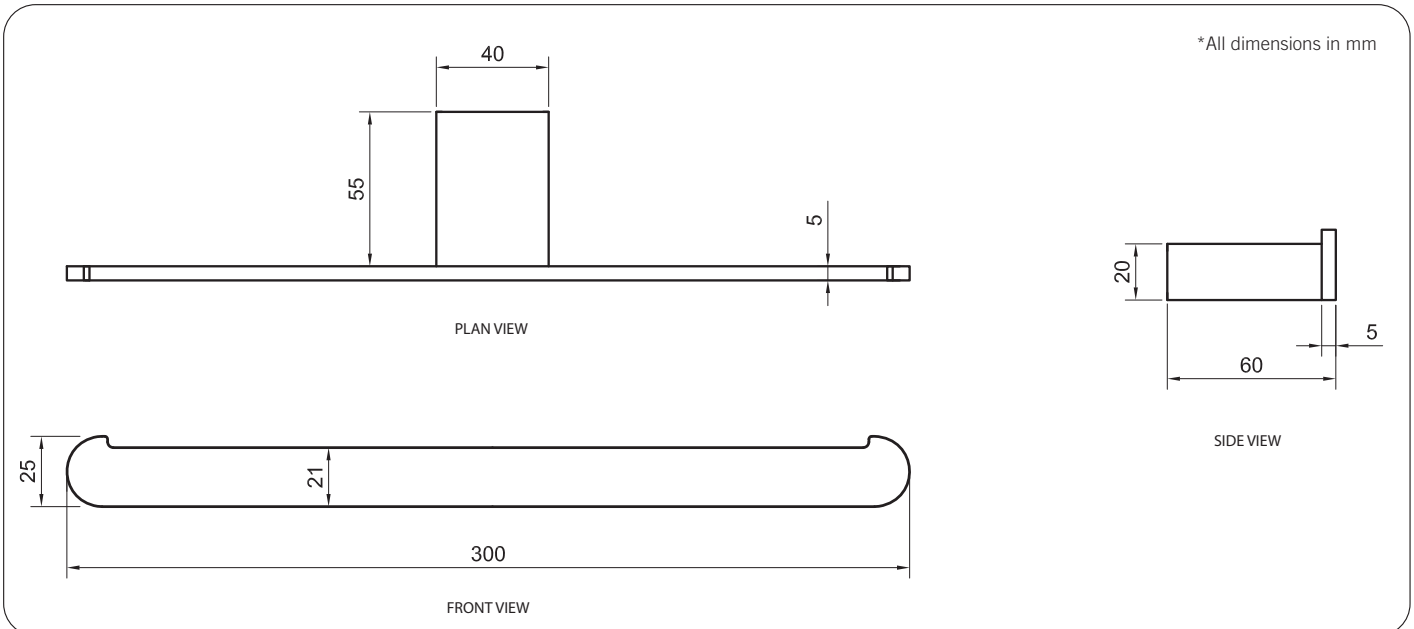

As improvements in the design and performance of RBA products are continuous, specifications may be subject to change without notice. The illustrations and descriptions herein are applicable to production as of the date of this Technical Data Sheet. Revised 04/21 © 2021 by RBA Group TD/Model RBA1631-322/0421